

Protector

PRD 032 039 100Y 8030 10 SM LN 66 00



Pole Mounted Road Lighting & Floodlight Luminaire



Luminaire Group	Road Lighting & Floodlight
Mounting Type	Pole Mounted
Luminaire Color	RAL 9005
Housing	Electrostatic Powder Coated Aluminium
Optics	4 mm Tempered Glass
Light Source	Mid Power LED
Electrical Protection Class	CLASS II
IP	66
IK	08
Operating Temperature	-20°C / +40°C
Luminous Flux	13000
Consumption Power	100
Luminaire Efficiency	130 lm/W
Color Rendering (CRI)	70
Light Color Temperature (CCT)	3000
Color Tolerance	< 3 SDCM
Driver Type	On/Off
Input Voltage / Frequency	220-240 V AC 50/60 Hz
Power Factor	>0.9
Surge	1kV
THD (AKIM)	>%20
LED life	>100.000 hours
Option	SPD, IP68 Connector

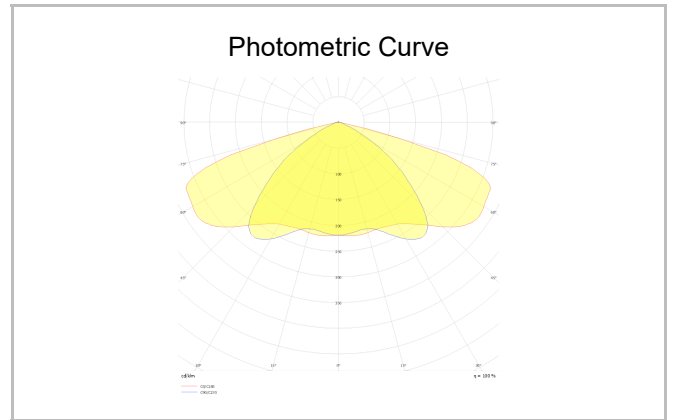
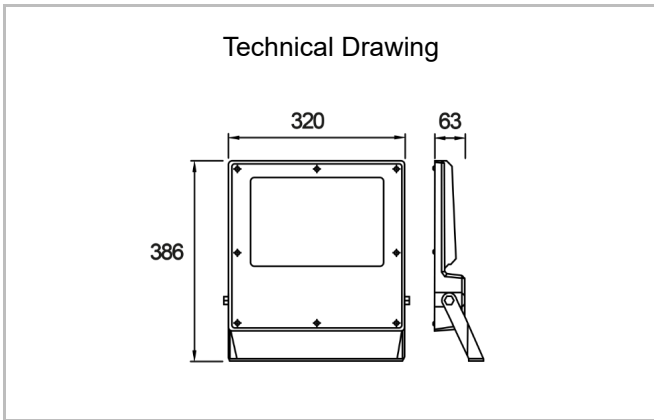

SKU	Product Code	Power (W)	Luminous Flux (LM)	CRI	CCT (K)	Optics	Dimensions (mm)
	PRD 032 039 100Y 8030 10 SM LN 66 00	100	13000	70	3000	Symmetrical Lens	386x320x63

www.atellighting.com