

Proflood

PRD 036 042 200Y 8030 10 AS LN 66 00



Road Lighting & Floodlight Luminary



Luminaire Group	Road Lighting & Floodlight
Luminary Color	RAL 9005
Housing	Electrostatic Powder Coated
Optics	4 mm Tempered Glass
Light Source	Mid Power LED
Electrical Protection Class	CLASS II
IP	66
IK	08
Operating Temperature	-20°C / +40°C
Luminous Flux	104000
Consumption Power	800
Luminaire Efficiency	130 lm/W
Color Rendering (CRI)	>70
Light Color Temperature (CCT)	3000K/4000K/6500K
Color Tolerance	< 3 SDCM
Driver Type	On/Off
Input Voltage / Frequency	220-240 V AC 50/60 Hz
Power Factor	>0.9
Surge	1kV
THD (AKIM)	>%20
LED life	>100.000 hours
Option	SPD, IP68 Connector

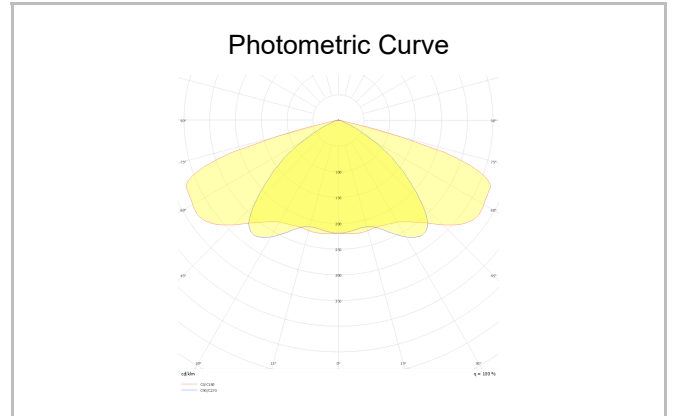
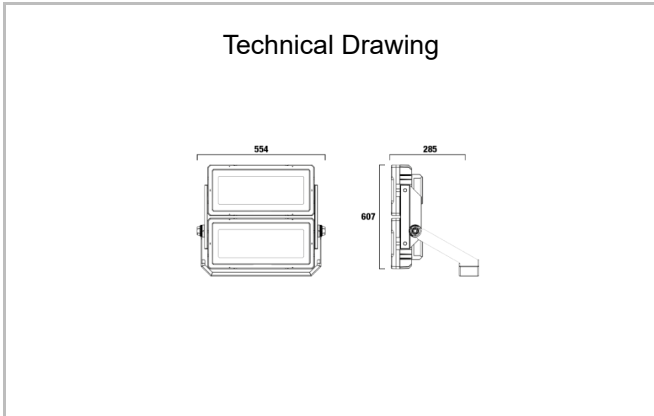

SKU	Product Code	Power (W)	Luminous Flux (LM)	CRI	CCT (K)	Optics	Dimensions (mm)
	PRD 036 042 200Y 8030 10 AS LN 66 00	800	104000	>70	4000	Asymmetrical Lens	554x607x285