

Drums

DRM 090 008 96S 8040 26 99 OP 40 00

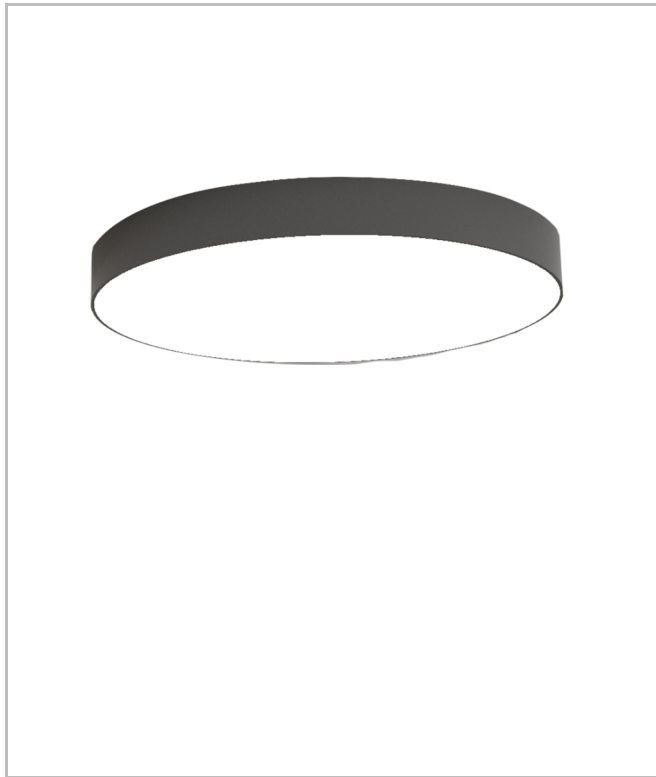

Surface Mounted Luminary



Luminaire Group	Surface Mounted
Mounting Type	Surface Mounted
Luminaire Color	RAL 9005 - RAL 9006 - RAL 9010
Housing	Aluminum Extrusion
Optics	Opal Diffuser
Light Source	LED
Electrical Protection Class	CLASS II
IP	40
IK	02
Operating Temperature	-20°C / +40°C
Luminous Flux	13095
Consumption Power	96
Luminaire Efficiency	124,5 lm/W
Color Rendering (CRI)	>80
Light Color Temperature (CCT)	2700K/3000K/4000K/6500K
Color Tolerance	< 3 SDCM
Driver Type	On/Off
Driver Brand	Tridonic
LED Brand	Samsung
Input Voltage / Frequency	220-240 V AC 50/60 Hz
Power Factor	>0.9
Surge	1kV
THD (AKIM)	>%20
LED life	>50.000 hours
Option	On-Off / Dali / 1-10V / With Emergency Kit

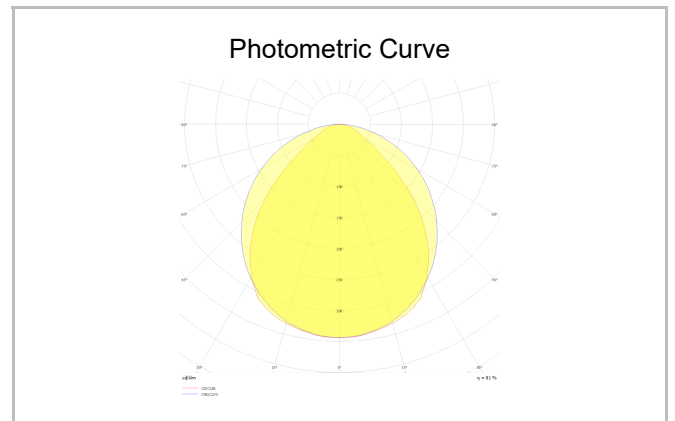
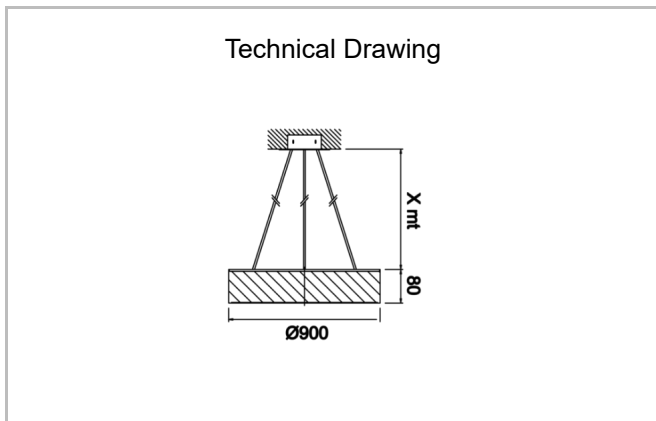

SKU	Product Code	Power (W)	Luminous Flux (LM)	CRI	CCT (K)	Optics	Dimensions (mm)
	DRM 090 008 96S 8040 26 99 OP 40 00	96	13095	>80	4000	120° Opal Diffuser	Ø90