

# Promete M

PRO 042 038 120Y 8040 10 AS LN 66 00



Road Lighting & Floodlight Luminary



<b>Luminaire Group</b>	Road Lighting & Floodlight
<b>Luminary Color</b>	RAL 9005
<b>Housing</b>	Aluminum Injection Electrostatic Powder Coated
<b>Optics</b>	Symmetrical / Asymmetrical° Lens & Tempered Glass
<b>Light Source</b>	LED
<b>Electrical Protection Class</b>	CLASS II
<b>IP</b>	66
<b>IK</b>	08
<b>Operating Temperature</b>	-40°C / +55°C
<b>Luminous Flux</b>	15600
<b>Consumption Power</b>	120
<b>Luminaire Efficiency</b>	120 lm/W
<b>Color Rendering (CRI)</b>	>70
<b>Light Color Temperature (CCT)</b>	3000K/4000K/6500K
<b>Color Tolerance</b>	< 3 SDCM
<b>Driver Type</b>	On/Off
<b>Input Voltage / Frequency</b>	220-240 V AC 50/60 Hz
<b>Power Factor</b>	>0.9
<b>Surge</b>	1kV
<b>THD (AKIM)</b>	>%20
<b>LED life</b>	>100.000 hours

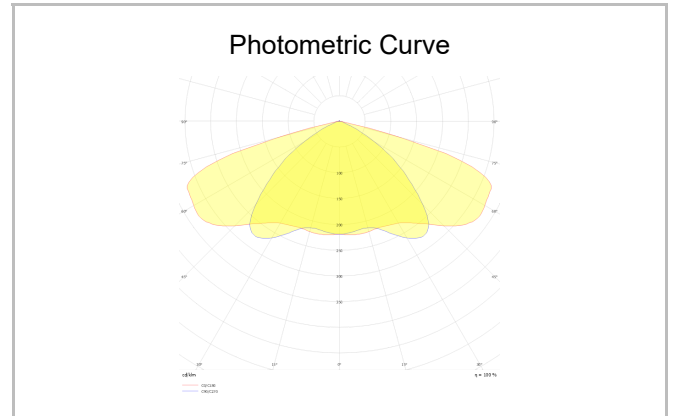
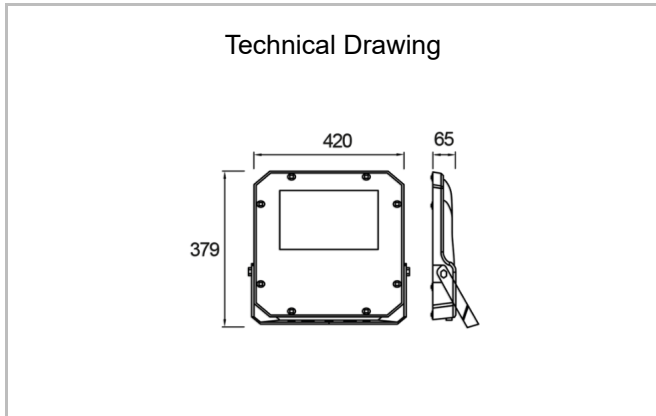

SKU	Product Code	Power (W)	Luminous Flux (LM)	CRI	CCT (K)	Optics	Dimensions (mm)
	PRO 042 038 120Y 8040 10 AS LN 66 00	120	15600	>70	4000	Asymmetric Lens	420x379x65