

Promete S

PMT 028 033 040Y 8040 10 SM LN 66 00

Road Lighting & Floodlight Luminary



Luminaire Group	Road Lighting & Floodlight
Luminary Color	RAL 9005
Housing	Aluminum Injection
Optics	Symmetrical / Asymmetrical° Lens & Tempered Glass
Light Source	LED
Electrical Protection Class	CLASS II
IP	66
IK	08
Operating Temperature	-40°C / +55°C
Luminous Flux	4800
Consumption Power	40
Luminaire Efficiency	120 lm/W
Color Rendering (CRI)	>70
Light Color Temperature (CCT)	3000K/4000K/6500K
Color Tolerance	< 3 SDCM
Driver Type	On/Off
Input Voltage / Frequency	220-240 V AC 50/60 Hz
Power Factor	>0.9
Surge	1kV
THD (AKIM)	>%20
LED life	>100.000 hours

Technical Drawing

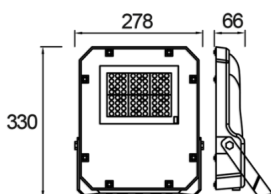

Photometric Curve

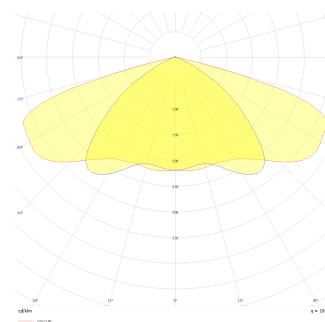

SKU	Product Code	Power (W)	Luminous Flux (LM)	CRI	CCT (K)	Optics	Dimensions (mm)
	PMT 028 033 040Y 8040 10 SM LN 66 00	40	4800	>70	4000	Symmetrical Lens	278x330x66

www.atellighting.com