

Roadster-M

ROA 018 051 120M 8040 10 AS CM 66 00



Road Lighting & Floodlight Luminary



Luminaire Group	Road Lighting & Floodlight
Luminary Color	RAL 9005
Housing	Aluminum Injection
Optics	Symmetrical / Asymmetrical° Lens & Tempered Glass
Light Source	LED
Electrical Protection Class	CLASS II
IP	66
IK	08
Operating Temperature	-40°C / +40°C
Luminous Flux	15000
Consumption Power	120
Luminaire Efficiency	125 lm/W
Color Rendering (CRI)	>70
Light Color Temperature (CCT)	3000K/4000K/6500K
Color Tolerance	< 3 SDCM
Driver Type	On/Off
Input Voltage / Frequency	220-240 V AC 50/60 Hz
Power Factor	>0.9
Surge	1kV
THD (AKIM)	>%20
LED life	>100.000 hours

Technical Drawing

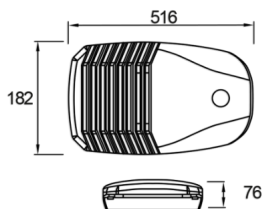

Photometric Curve

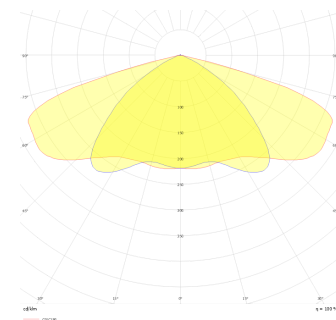

SKU	Product Code	Power (W)	Luminous Flux (LM)	CRI	CCT (K)	Optics	Dimensions (mm)
	ROA 018 051 120M 8040 10 AS CM 66 00	120	15000	>70	4000	Asymmetric Lens	182x516x76 mm

www.atellighting.com