

# Luma

LMA 005 150 066S 8040 10 99 OP 65 00



Surface Mounted Industrial Luminaire



<b>Luminaire Group</b>	Industrial
<b>Mounting Type</b>	Surface Mounted
<b>Housing</b>	Aluminum Anodized Coating
<b>Optics</b>	Opal PC Diffuser
<b>Light Source</b>	LED
<b>Electrical Protection Class</b>	CLASS II
<b>IP</b>	65
<b>IK</b>	09
<b>Operating Temperature</b>	-20°C / +40°C
<b>Luminous Flux</b>	7986
<b>Consumption Power</b>	66
<b>Luminaire Efficiency</b>	123 lm/W
<b>Color Rendering (CRI)</b>	>80
<b>Light Color Temperature (CCT)</b>	2700K / 3000K / 4000K / 6500K
<b>Color Tolerance</b>	< 3 SDCM
<b>Driver Type</b>	On/Off
<b>Driver Brand</b>	Tridonic
<b>LED Brand</b>	Samsung
<b>Input Voltage / Frequency</b>	220-240 V AC 50/60 Hz
<b>Power Factor</b>	>0.9
<b>Surge</b>	1kV
<b>THD (AKIM)</b>	>%20
<b>LED life</b>	70.000 hours
<b>Option</b>	On-Off / Dali / 1-10V / With Emergency Kit

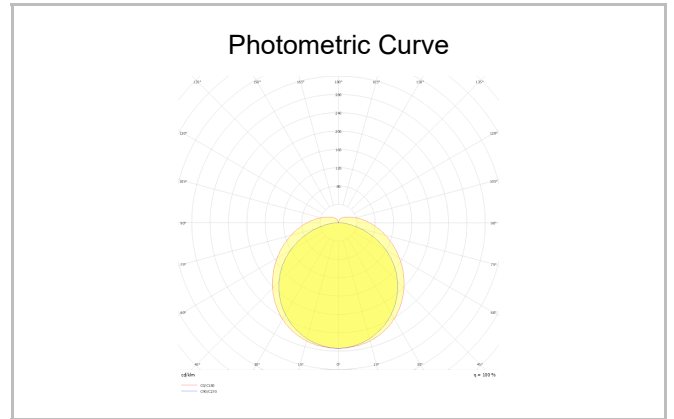
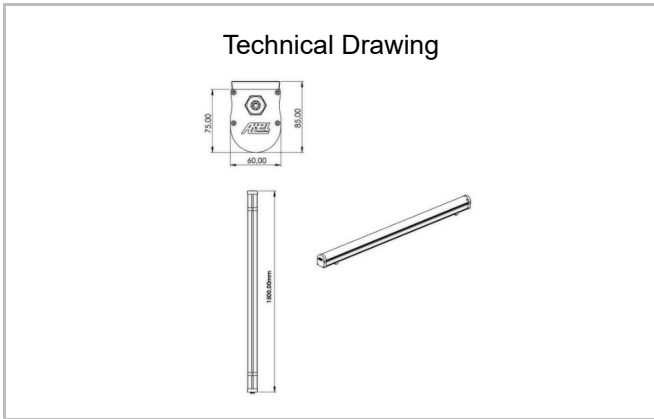

SKU	Product Code	Power (W)	Luminous Flux (LM)	CRI	CCT (K)	Optics	Dimensions (mm)
	LMA 005 150 066S 8040 10 99 OP 65 00	66	7986	>80	4000	120° Opal PC Diffuser	84x75x1500