

Luma

LMA 005 150 046S 8040 10 99 OP 65 00



Surface Mounted Industrial Luminaire



Luminaire Group	Industrial
Mounting Type	Surface Mounted
Housing	Aluminum Anodized Coating
Optics	Opal PC Diffuser
Light Source	LED
Electrical Protection Class	CLASS II
IP	65
IK	09
Operating Temperature	-20°C / +40°C
Luminous Flux	5658
Consumption Power	46
Luminaire Efficiency	123 lm/W
Color Rendering (CRI)	>80
Light Color Temperature (CCT)	2700K / 3000K / 4000K / 6500K
Color Tolerance	< 3 SDCM
Driver Type	On/Off
Driver Brand	Tridonic
LED Brand	Samsung
Input Voltage / Frequency	220-240 V AC 50/60 Hz
Power Factor	>0.9
Surge	1kV
THD (AKIM)	>%20
LED life	70.000 hours
Option	On-Off / Dali / 1-10V / With Emergency Kit

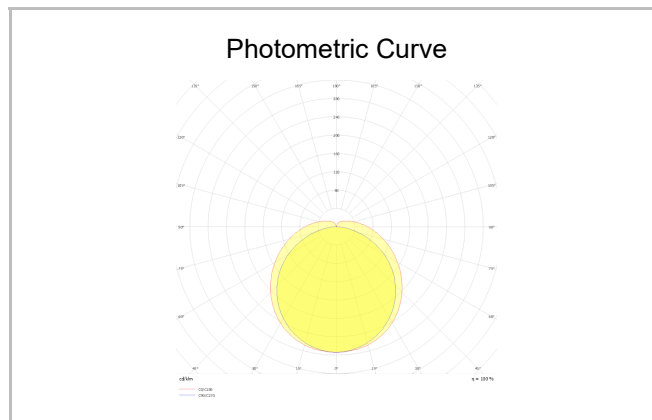
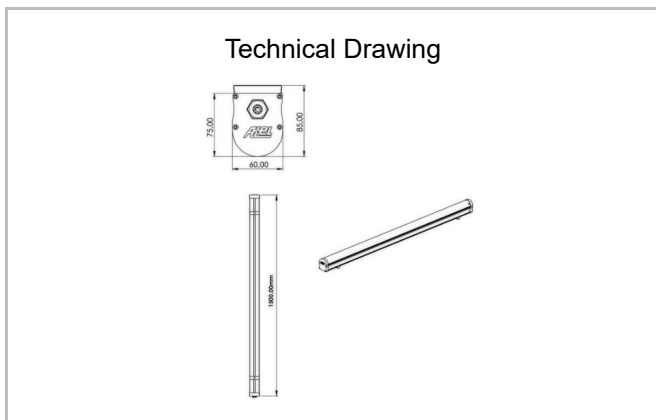

SKU	Product Code	Power (W)	Luminous Flux (LM)	CRI	CCT (K)	Optics	Dimensions (mm)
	LMA 005 150 046S 8040 10 99 OP 65 00	46	5658	>80	4000	120° Opal PC Diffuser	1500x60x75

www.atellighting.com