

Shackle

SHA 013 015 018W 8040 10 55 CA 20 00



Track Lighting Luminary



Luminaire Group	Track Lighting
Luminary Color	RAL 9005 - RAL 9006 - RAL 9010
Housing	Aluminum
Optics	19° 30° 55° Reflector and Diffuser
Light Source	LED
Electrical Protection Class	CLASS II
IP	20
IK	02
Operating Temperature	-20°C / +40°C
Luminous Flux	2080
Consumption Power	26
Luminaire Efficiency	80 lm/W
Color Rendering (CRI)	>80
Light Color Temperature (CCT)	2700K/3000K/4000K/6500K
Color Tolerance	< 3 SDCM
Driver Type	On/Off
Driver Brand	Tridonic
LED Brand	Samsung
Input Voltage / Frequency	220-240 V AC 50/60 Hz
Power Factor	>0.9
Surge	1kV
THD (AKIM)	>%20
LED life	>70.000 hours
Option	On-Off / Dali / 1-10V

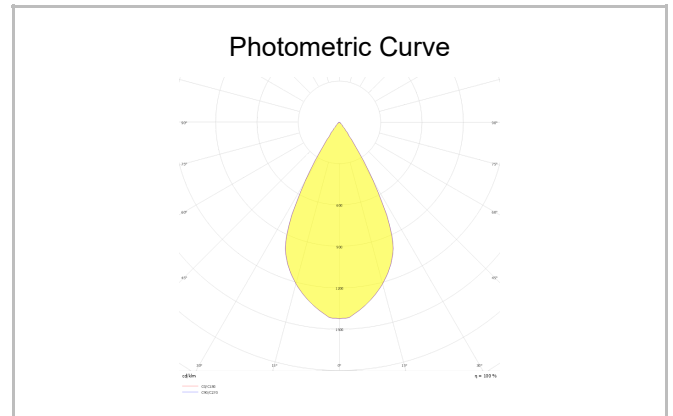
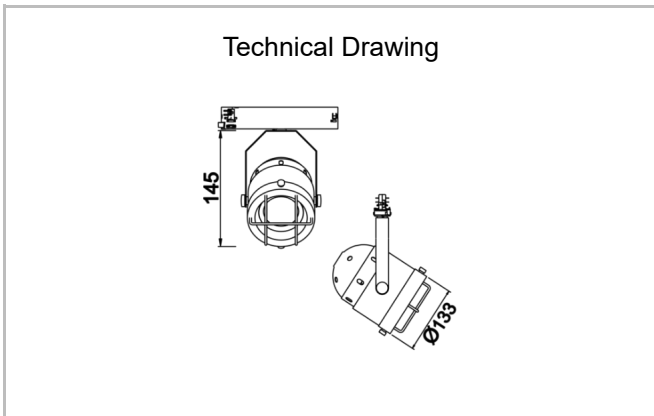

SKU	Product Code	Power (W)	Luminous Flux (LM)	CRI	CCT (K)	Optics	Dimensions (mm)
	SHA 013 015 018W 8040 10 55 CA 20 00	26	2080	>80	4000	55° Reflector	Ø133x145

www.atellighting.com