

# Shackle

SHA 013 015 013W 8040 10 30 CA 20 00



Track Lighting Luminary



<b>Luminaire Group</b>	Track Lighting
<b>Luminary Color</b>	RAL 9005 - RAL 9006 - RAL 9010
<b>Housing</b>	Aluminum
<b>Optics</b>	19° 30° 55° Reflector and Diffuser
<b>Light Source</b>	LED
<b>Electrical Protection Class</b>	CLASS II
<b>IP</b>	20
<b>IK</b>	02
<b>Operating Temperature</b>	-20°C / +40°C
<b>Luminous Flux</b>	1440
<b>Consumption Power</b>	18
<b>Luminaire Efficiency</b>	80 lm/W
<b>Color Rendering (CRI)</b>	>80
<b>Light Color Temperature (CCT)</b>	2700K/3000K/4000K/6500K
<b>Color Tolerance</b>	< 3 SDCM
<b>Driver Type</b>	On/Off
<b>Driver Brand</b>	Tridonic
<b>LED Brand</b>	Samsung
<b>Input Voltage / Frequency</b>	220-240 V AC 50/60 Hz
<b>Power Factor</b>	>0.9
<b>Surge</b>	1kV
<b>THD (AKIM)</b>	>%20
<b>LED life</b>	>70.000 hours
<b>Option</b>	On-Off / Dali / 1-10V

Technical Drawing

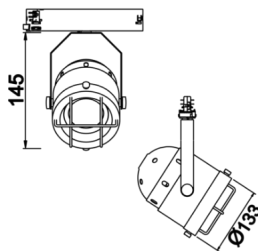

Photometric Curve

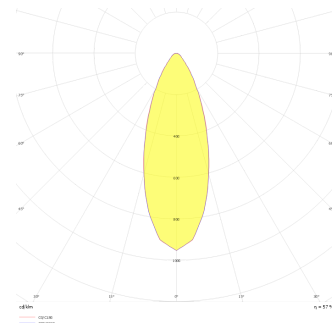

SKU	Product Code	Power (W)	Luminous Flux (LM)	CRI	CCT (K)	Optics	Dimensions (mm)
	SHA 013 015 013W 8040 10 30 CA 20 00	18	1440	>80	4000	30° Reflector	Ø133x145

[www.atellighting.com](http://www.atellighting.com)