

Filtrum

FIL 635 335 009A 8040 10 99 OP 20 01



Pendant Acoustic Solutions Luminary



Luminaire Group	Acoustic Solutions
Mounting Type	Pendant
Housing	Acoustic Panel
Optics	Opal Diffuser
Light Source	LED
Electrical Protection Class	CLASS II
IP	20
IK	02
Operating Temperature	-20°C / +40°C
Luminous Flux	990
Consumption Power	9
Luminaire Efficiency	125 lm/W
Color Rendering (CRI)	>80
Light Color Temperature (CCT)	2700K/3000K/4000K/6500K
Color Tolerance	< 3 SDCM
Driver Type	On/Off
Driver Brand	Tridonic
LED Brand	Samsung
Input Voltage / Frequency	220-240 V AC 50/60 Hz
Power Factor	>0.9
Surge	1kV
THD (AKIM)	>%20
LED life	>70.000 hours
Option	On-Off / Dali / 1-10V / With Emergency Kit

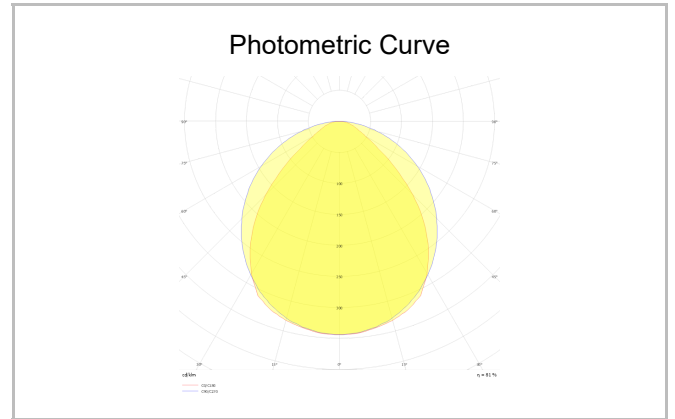
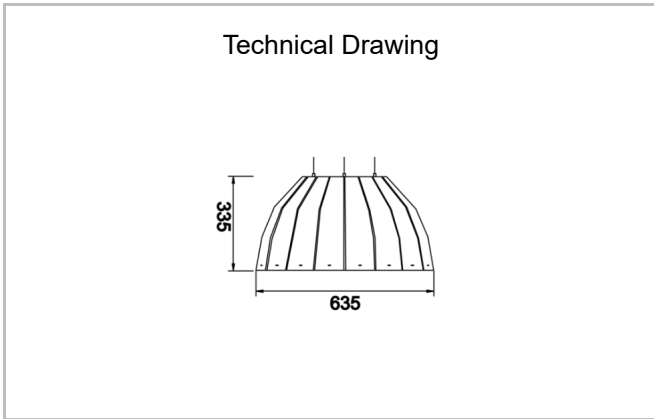

SKU	Product Code	Power (W)	Luminous Flux (LM)	CRI	CCT (K)	Optics	Dimensions (mm)
	FIL 635 335 009A 8040 10 99 OP 20 01	9	990	>80	4000	120° Opal Diffuser	Ø635x335

www.atellighting.com