

Easy Pendant

ESY 060 060 038P 8040 10 99 OP 20 00



Pendant Luminary



Luminaire Group	Pendant
Mounting Type	Pendant
Luminaire Color	RAL 9005 - RAL 9006 - RAL 9010
Housing	DKP Sheet
Optics	E27 Headlight
Electrical Protection Class	CLASS II
IP	20
IK	02
Operating Temperature	-20°C / +40°C
Luminous Flux	4700
Consumption Power	38
Luminaire Efficiency	124 lm/W
Color Rendering (CRI)	>80
Light Color Temperature (CCT)	2700K/3000K/4000K/6500K
Color Tolerance	< 3 SDCM
Driver Type	On/Off
Driver Brand	Tridonic
LED Brand	Samsung
Input Voltage / Frequency	220-240 V AC 50/60 Hz
Power Factor	>0.9
Surge	1kV
THD (AKIM)	>%20
LED life	>70.000 hours
Option	On-Off / Dali / 1-10V / With Emergency Kit

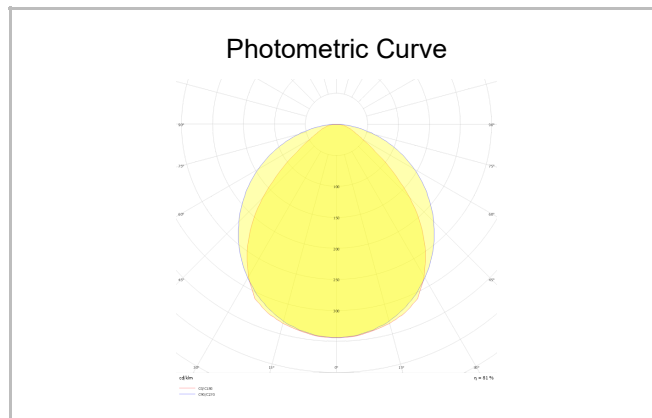
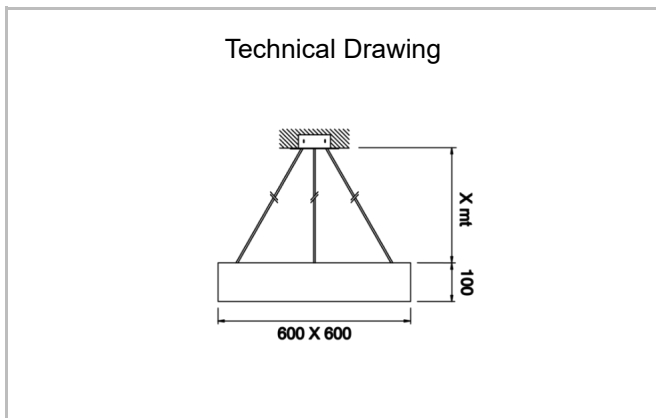

SKU	Product Code	Power (W)	Luminous Flux (LM)	CRI	CCT (K)	Optics	Dimensions (mm)
	ESY 060 060 038P 8040 10 99 OP 20 00	38	4700	>80	4000	120° Diffuser	600x600x100

www.atellighting.com