

# Pure M

PUR 009 008 013T 8040 10 30 SD 40 00



Recessed Downlight & Spot Luminary



<b>Luminaire Group</b>	Downlight & Spot
<b>Mounting Type</b>	Recessed
<b>Luminary Color</b>	RAL 9005 - RAL 9010
<b>Housing</b>	Aluminum Injection
<b>Optics</b>	15° 30° 40° Reflector & Transparent Diffuser
<b>Light Source</b>	LED
<b>Electrical Protection Class</b>	CLASS II
<b>IP</b>	40
<b>Operating Temperature</b>	-20°C / +40°C
<b>Luminous Flux</b>	1170
<b>Consumption Power</b>	13
<b>Luminaire Efficiency</b>	90 lm/W
<b>Color Rendering (CRI)</b>	>80
<b>Light Color Temperature (CCT)</b>	2700K/3000K/4000K/6500K
<b>Color Tolerance</b>	< 3 SDCM
<b>Driver Type</b>	On/Off
<b>Driver Brand</b>	Tridonic
<b>LED Brand</b>	Samsung
<b>Input Voltage / Frequency</b>	220-240 V AC 50/60 Hz
<b>Power Factor</b>	>0.9
<b>Surge</b>	1kV
<b>THD (AKIM)</b>	>%20
<b>LED life</b>	>70.000 hours
<b>Option</b>	On-Off / Dali / 1-10V / With Emergency Kit

Technical Drawing

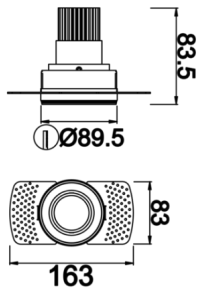

Photometric Curve

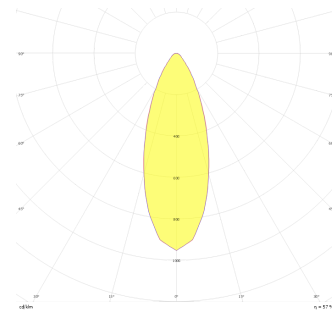

SKU	Product Code	Power (W)	Luminous Flux (LM)	CRI	CCT (K)	Optics	Dimensions (mm)
13000325	PUR 009 008 013T 8040 10 30 SD 40 00	13	1170	>80	4000	30° Reflector	Ø89,5x83,5

[www.atellighting.com](http://www.atellighting.com)