

Pure M

PUR 009 008 009T 8040 10 15 SD 40 00



Recessed Downlight & Spot Luminary



Luminaire Group	Downlight & Spot
Mounting Type	Recessed
Luminary Color	RAL 9005 - RAL 9010
Housing	Aluminum Injection
Optics	15° 30° 40° Reflector & Transparent Diffuser
Light Source	LED
Electrical Protection Class	CLASS II
IP	40
Operating Temperature	-20°C / +40°C
Luminous Flux	810
Consumption Power	9
Luminaire Efficiency	90 lm/W
Color Rendering (CRI)	>80
Light Color Temperature (CCT)	2700K/3000K/4000K/6500K
Color Tolerance	< 3 SDCM
Driver Type	On/Off
Driver Brand	Tridonic
LED Brand	Samsung
Input Voltage / Frequency	220-240 V AC 50/60 Hz
Power Factor	>0.9
Surge	1kV
THD (AKIM)	>%20
LED life	>70.000 hours
Option	On-Off / Dali / 1-10V / With Emergency Kit

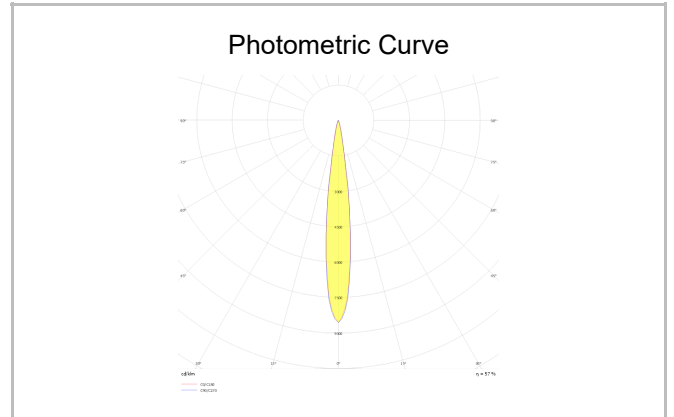
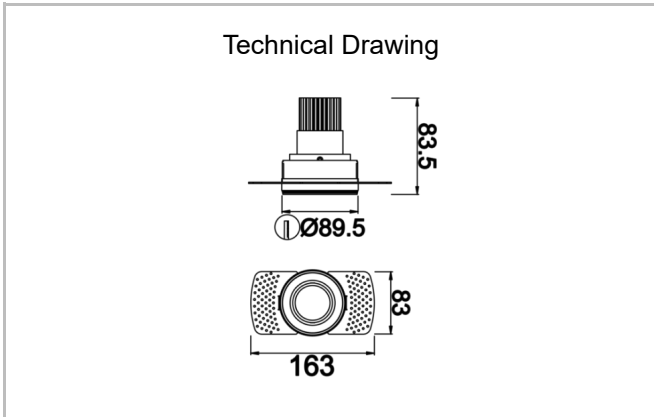

SKU	Product Code	Power (W)	Luminous Flux (LM)	CRI	CCT (K)	Optics	Dimensions (mm)
13000253	PUR 009 008 009T 8040 10 15 SD 40 00	9	810	>80	4000	15° Reflector	Ø89,5x83,5