

Rainbow Deep

RNB 010 015 007A 9040 10 15 SD 44 DP



Recessed Downlight & Spot Luminary



Luminaire Group	Downlight & Spot
Mounting Type	Recessed
Luminaire Color	RAL 9010 - RAL 9005 - RAL 9006 - RAL 9016
Housing	Aluminum Extrusion
Optics	15° 30° 40° Reflector & Transparent Diffuser
Light Source	LED
Electrical Protection Class	CLASS II
IP	44
IK	03
Operating Temperature	-20°C / +40°C
Luminous Flux	511
Consumption Power	7
Luminaire Efficiency	73 lm/W
Color Rendering (CRI)	>80
Light Color Temperature (CCT)	2700K/3000K/4000K/6500K
Color Tolerance	< 3 SDCM
Driver Type	On/Off
Driver Brand	Tridonic
LED Brand	Samsung
Input Voltage / Frequency	220-240 V AC 50/60 Hz
Power Factor	>0.9
Surge	1kV
THD (AKIM)	>%20
LED life	>102.000 hours
Option	On-Off / Dali / 1-10V / With Emergency Kit

Technical Drawing

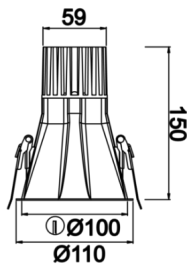

Photometric Curve

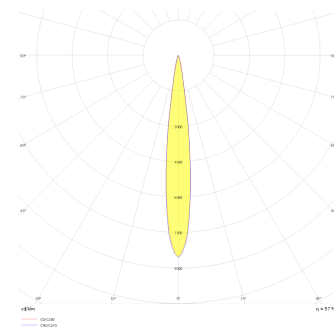

SKU	Product Code	Power (W)	Luminous Flux (LM)	CRI	CCT (K)	Optics	Dimensions (mm)
	RNB 010 015 007A 9040 10 15 SD 44 DP	7	511	>80	4000	15° Reflector	Ø110

www.atellighting.com