

Outline Level M

OUT 100 171 039A 8030 10 99 OP 40 LV

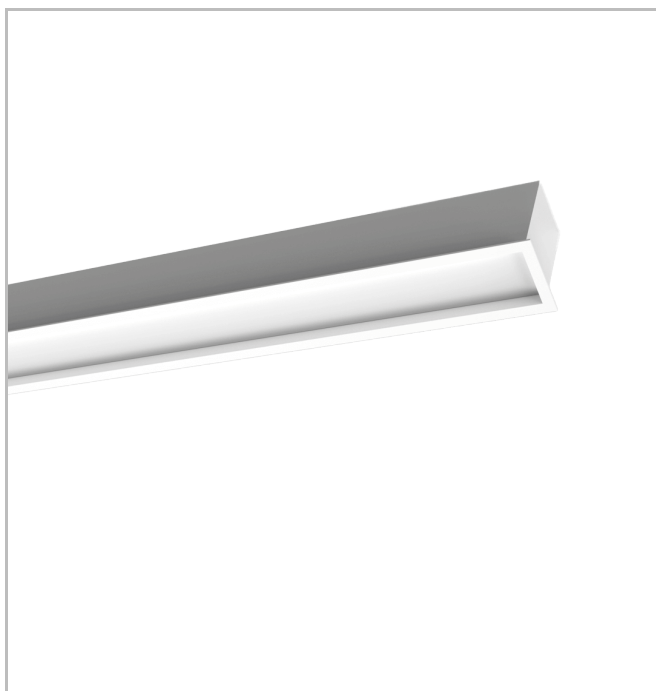

Recessed Linear Luminary



Luminaire Group	Linear
Mounting Type	Recessed
Luminary Color	RAL 9016 - RAL 9010
Housing	Aluminum extruded profile
Optics	Opal Diffuser
Light Source	LED
Electrical Protection Class	CLASS II
Operating Temperature	-20°C / +40°C
Luminous Flux	3526
Consumption Power	39
Luminaire Efficiency	92,81 lm/W
Color Rendering (CRI)	>80
Light Color Temperature (CCT)	2700K/3000K/4000K/6500K
Color Tolerance	< 3 SDCM
Driver Type	On/Off
Driver Brand	Tridonic
LED Brand	Samsung
Input Voltage / Frequency	220-240 V AC 50/60 Hz
Power Factor	>0.9
Surge	1kV
THD (AKIM)	>%20
LED life	>70.000 hours
Option	On-Off / Dali / 1-10V / With Emergency Kit

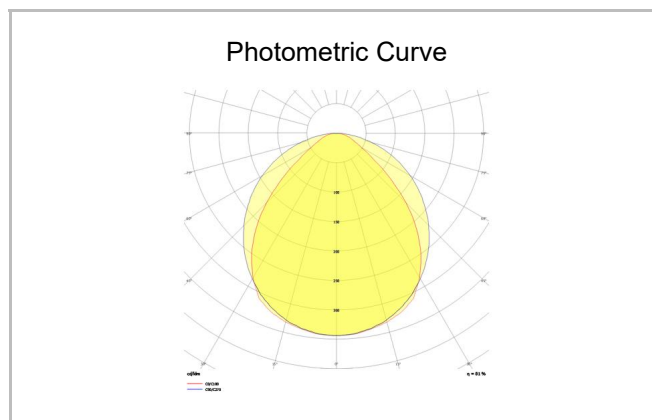
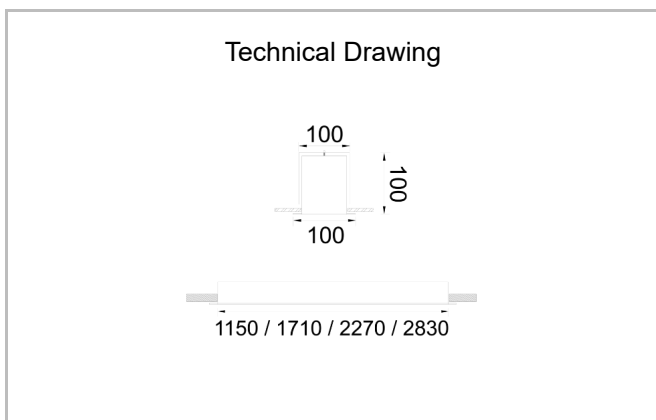

SKU	Product Code	Power (W)	Luminous Flux (LM)	CRI	CCT (K)	Optics	Dimensions (mm)
	OUT 100 171 039A 8030 10 99 OP 40 LV	39	3526	>80	4000	120° Opal Diffuser	1710x100x100